



# DC-H25-SL

## STANDARD ARM TEMPLATE

POWER SIZE	IDEAL WIDTH	IDEAL WEIGHT	MAX OPENING	POWER ADJUSTMENT
EN2	850mm	40kg	180°	0 TURNS (DEFAULT)
EN3	950mm	60kg	180°	4 TURNS
EN4	1100mm	80kg	180°	7 TURNS
EN5	1250mm	100kg	180°	11 TURNS

 <b>FAST</b> <b>SLOW</b>	 <b>WEAK</b> <b>STRONG</b>
DELAY ACTION LATCHING SPEED CLOSING SPEED	POWER SIZE BACK CHECK

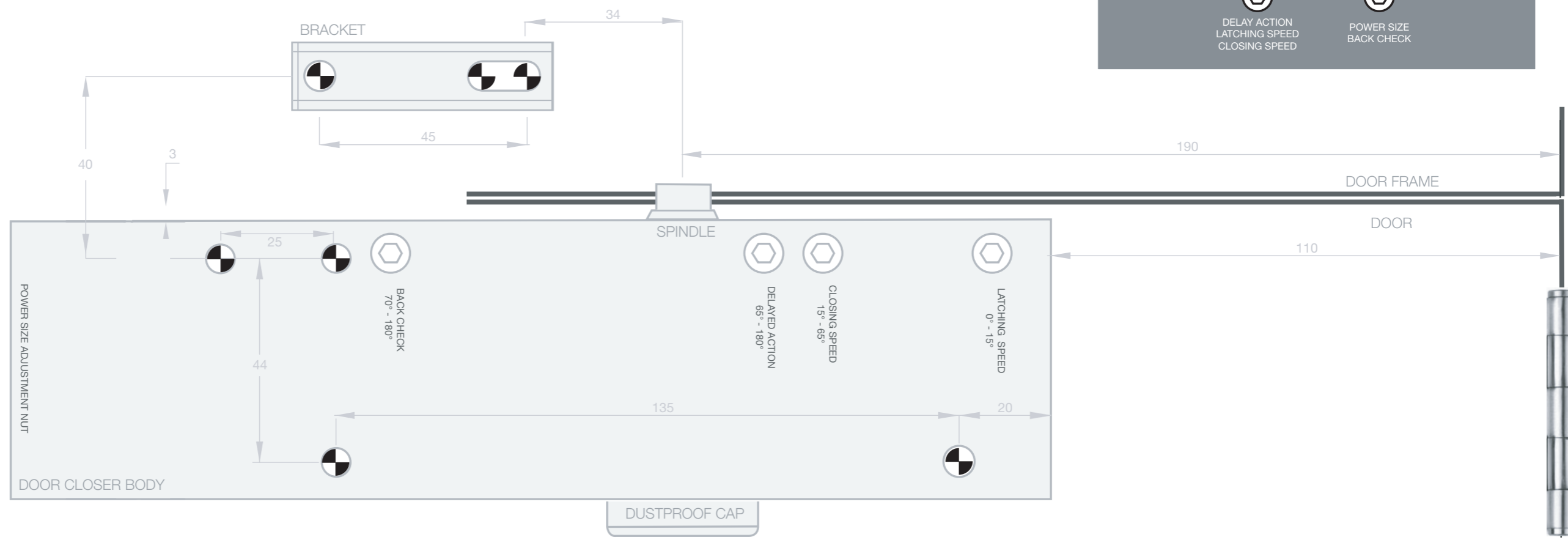
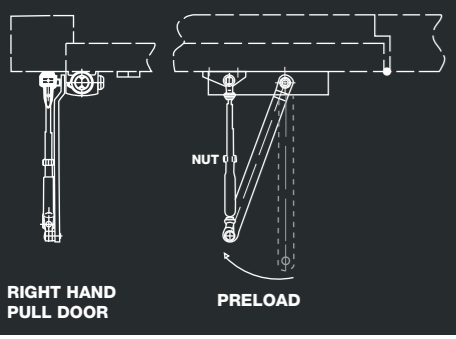
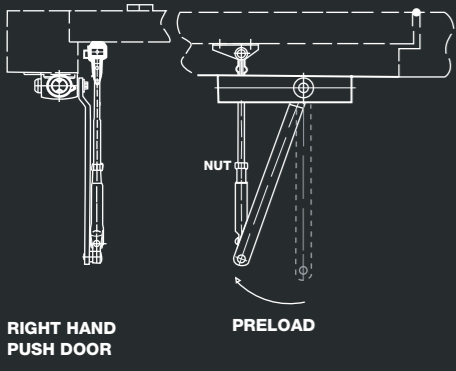

RIGHT HAND **PULL** DOOR TEMPLATE

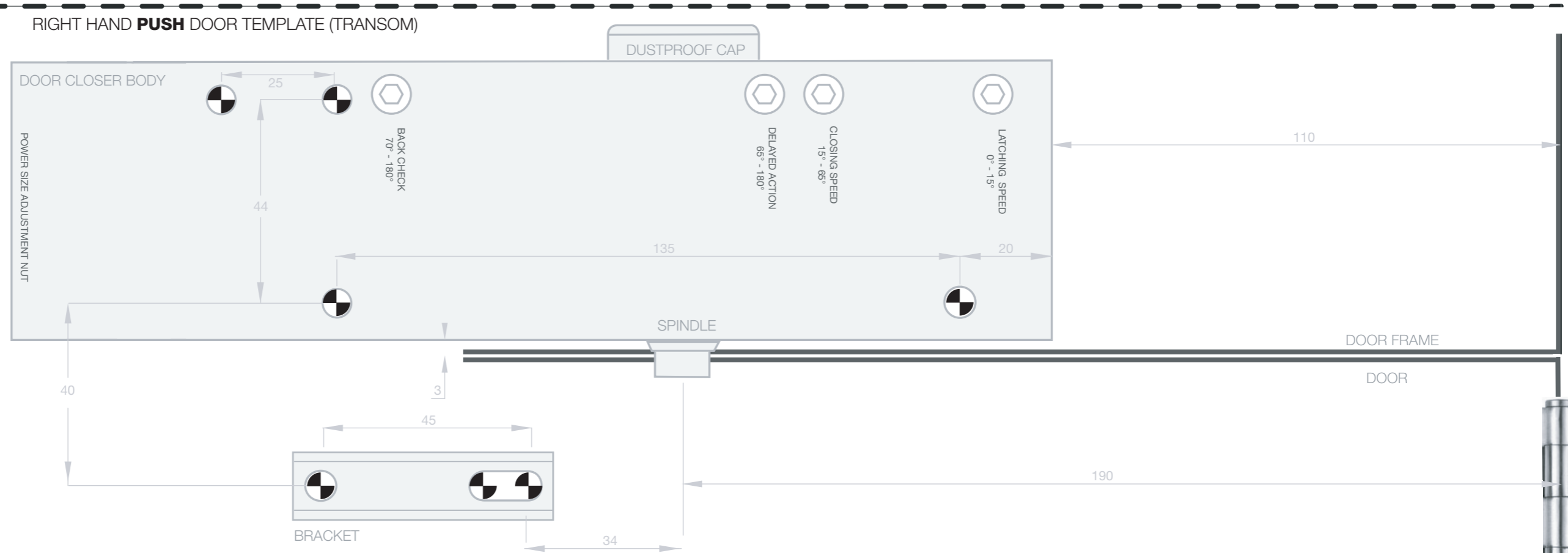

RIGHT HAND **PUSH** DOOR TEMPLATE (TRANSOM)

### ASSEMBLY STEPS

1. Pre-drill appropriate holes using the template provided.
2. Position and mount the door closer.
3. Position and fasten the standard arm to the door closer body so that it is 90° from the door.
4. Preload the arm roughly 45° as per the diagrams beside the templates.
5. Unscrew the nut to adjust the length of the arm so that the bracket is able to be attached as per the template.
6. Fasten the bracket to the door.
7. Ensure the nut on the arm is tightened after the bracket has been fixed to the door or door frame.

### ADJUSTMENT STEPS

1. Begin by adjusting the power size in accordance to the weight and width of the door. The table provides the amount of turns required to increase or decrease the power size to particular EN values.
2. Adjust delayed action, closing speed and latching speed in any order you desire.
3. Adjust the back check to your desired amount.

# DC-H25-SL

## STANDARD ARM TEMPLATE

CE Power Adjustable EN2-EN5  
 EN 1154:1996/A1:2002/AC:2006  
 0359-CPR-00346  
 14

**designer doorware**  
 making it personal

7 Kimpton Way  
 Altona  
 3018 VIC

4	8	5	1	1	3
---	---	---	---	---	---

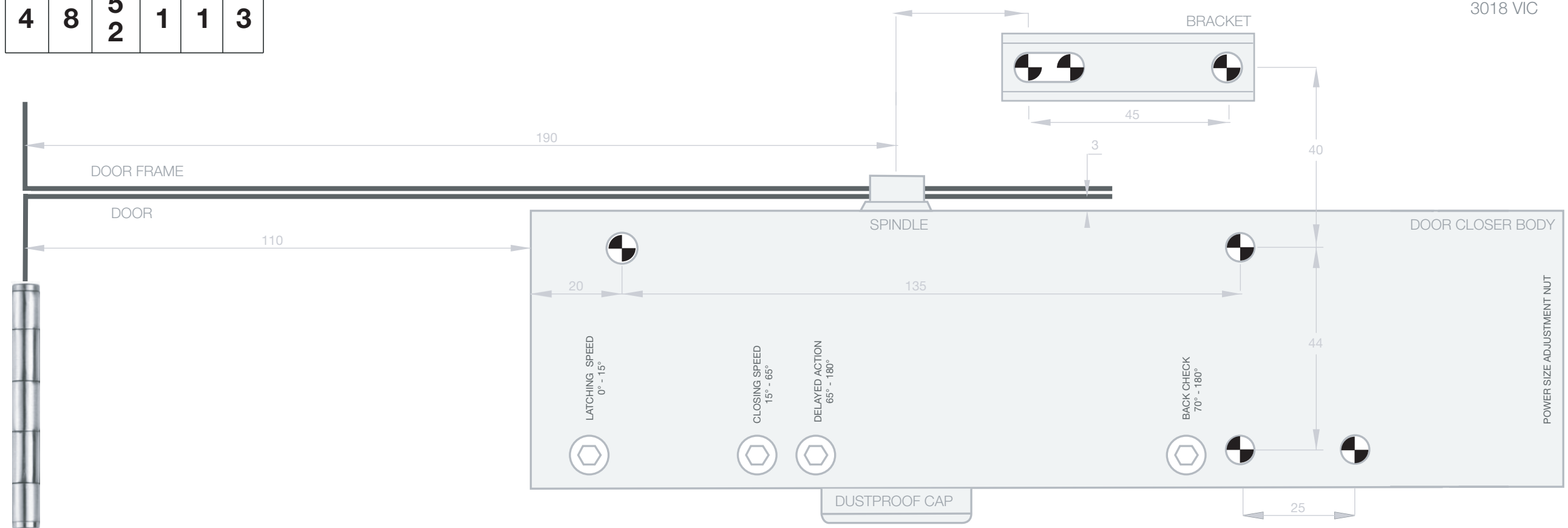

LEFT HAND **PULL** DOOR TEMPLATE

LEFT HAND **PUSH** DOOR TEMPLATE (TRANSOM)

